

THE NUCLEAR “MUKKULAM”?...
(A new theory on “Mukkil”)



*M. Arulmani, B.E.
(Engineer)*

m.arulmani58@gmail.com



*V.R. Hema Latha, M.A., M.Sc., M.Phil.
(Biologist)*

vrhemalatha58@gmail.com

1. Abstract:

In the Early Universe “**MUKKIL**” shall be considered as the **1st generation** natural Electromagnetic spectrum. “**MUKKIL**” shall mean “cloud of absolutely white radiations”. The cloud of “**white spectrum**” considered contains billions of “**Rays**” and each ray considered represents every initially “**CREATED**” matter exists in the universe. The white spectrum shall also be called as “**J-spectrum**”. In J-spectrum every ray considers containing fundamental particles called “**J-particles**”.

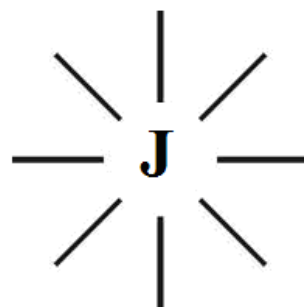

(MUKKIL)

In the so called “**Expanding Universe**” the three families of spectrum shall be considered “**EVOLVED**” in three “**Nuclear age**” of geological periods. The three genetically varied families of natural spectrum shall be called as “**MUKKULAM**”. The so called “**Electromagnetic spectrum**” focused in Quantum physics shall be considered as “**3rd generation coloured spectrum**” composed of Billions of colours under three distinguished band of **UV, RF, IR** having distinguished wavelength, Frequency and energy level can be classified under major three nuclear family α , β , γ .

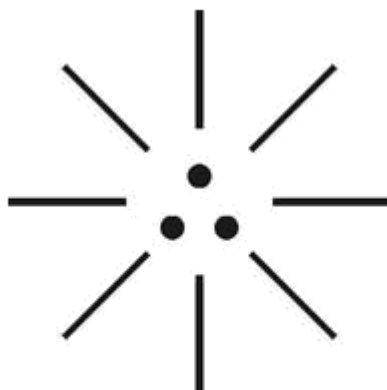

(MUKKULAM)

It is speculated that this scientific research shall provide balanced solutions to the conflicts in ‘**particle-wave**’ property of matters focused in uncertainty principle, **Einstein’s** relativity theory, **Newton’s** gravitational theory, **Tesla’s** Aether Principle and **Maxwell’s** electromagnetic wave theory.

J-Spectrum shall be considered as mother of α , β , γ children.

- Author

2. Key Words:

- 1) Philosophy of Acronym “**MGR**” (Mzee)
- 2) Philosophy of word “**MUTHU**” (White Matter)
- 3) Philosophy of word “**MUCHU**” (Breath)

- 4) Philosophy of word "**MULAI**" (Plasma)
- 5) Philosophy of word "**MULAM**" (Soul)
- 6) Philosophy of word "**MUDI**" (Hair)
- 7) Philosophy of word "**MUNU, MUNDRU**" (Three)
- 8) Philosophy of word "**MUTHAM**" (Nutrine)
- 9) Philosophy of word "**MUTHAMIL**" (Logic)
- 10) Philosophy of word "**MUKAM**" (Band)
- 11) Philosophy of word "**MUTHIRAM**" (Neuro Fluid)
- 12) Philosophy of word "**MUCHU**" (Breath)
- 13) Philosophy of word "**MULAI, MUKULAM**" (Brain and Spine)
- 14) Philosophy of word "**MUKKU**" (Nose)
- 15) Philosophy of word "**MUVAR**" (Three)
- 16) Philosophy of word "**MUNIVAR**" (Alien)
- 17) Philosophy of word "**MUKKU**" (Corner)
- 18) Philosophy of word "**MURUKKU**" (Twist)
- 19) Philosophy of word "**MUTHIR**" (Creation)
- 20) Philosophy of word "**MURAM**" (Spectrum)
- 21) Philosophy of word "**MUTHAL**" (Origin)
- 22) Philosophy of word "**MUDIVU**" (End)
- 23) Philosophy of word "**MURIVU**" (Decay)
- 24) Philosophy of word "**MU**" (Greek Word)
- 25) Philosophy of word "**MUNUMUNUTHAL**" (Pulse Music)

3. Introduction:

In the "**Evolutionary theory**" and Darwin's origin of "**species**", Human is considered as evolved from "**APES**" and Human and Apes are considered as having "**Common Ancestor**". In this article it is emphasized that human has more **genetic value** than APES and human is considered as valuable **Gift of Nature**.

In this scientific research it is focused that the so called "**Modern human**" (Homo sapien sapien) living in **EARTH PLANET** shall be considered as **3rd generation human species**. In the Early universe all

the matters including human shall be considered as “**CREATED PRODUCT**” supernatural force called “**GOD**”. In the expanding universe the human and all matters shall be considered undergone **three genetic changes** in “**Three Nuclear age**”. The three genetically evolved human populations shall be considered belong to three distinguished nuclear family called “**Mukkulam**” derived from “**J-Family**”.

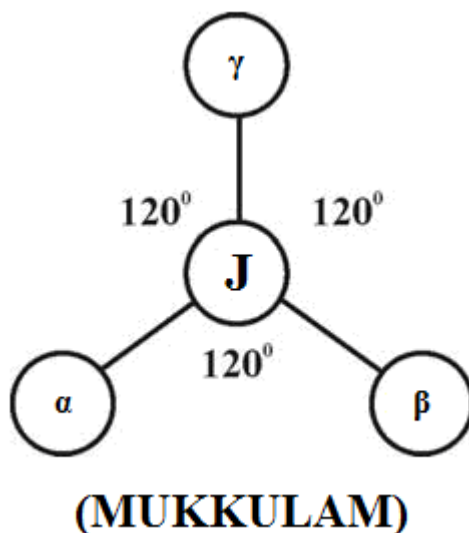

The “**1st generation human**” (called as **THAMEEN**) shall be considered lived in “**MARS PLANET**” with genetic characteristics and capable of “**FLYING**”. **THAMEEN** shall be considered as human populations shall be considered as “**DARK POPULATIONS**” who lived in MARS planet even before the “**SUN**” emits its **first Light**.

The 1st generation human shall be considered as expert in **Astronomy, Astro physics, Bio Science** and communicated with “**High level language**” with only Single alphabet composed of “**Three-in-one Tiny dot**”.

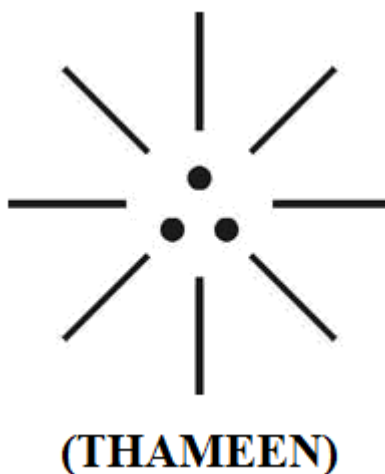

The high level language shall be considered as considered contain series of “**PULSES**” of fundamental Neutrino particles **PHOTON, ELECTRON, PROTON**. Each particle shall be considered having own characteristics “**pulses digit**” as mentioned below called as “**MARS CODE**” (or) “**AKKIE CODE**”.

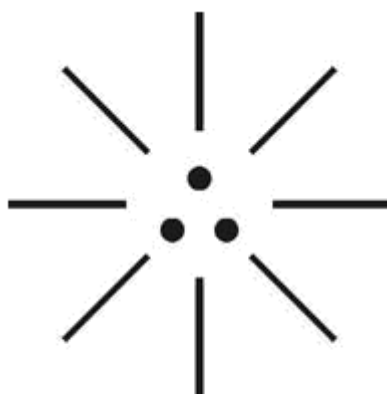

(AKKIE KODU)

- i) Right dot – “**1**” (PROTON)
- ii) Left dot – “**0**” (ELECTRON)
- iii) Centre dot – “**.**” (PHOTON)

It is focused that the so called **Mayan code, Morse Code, Binary code** shall be considered as **3rd generation** digital language derived from the philosophy of **1st generation pulse language**.

4. Previous Publication:

The philosophy of origin of first life and human, the philosophy of model Cosmo Universe, the philosophy of fundamental neutrino particles have already been published in various international journals mentioned below. Hence this article shall be considered as **extended version** of the previous articles already published by the same author.

- [1] Cosmo Super Star – IJSRP, April issue, 2013
- [2] Super Scientist of Climate control – IJSER, May issue, 2013
- [3] AKKIE MARS CODE – IJSER, June issue, 2013
- [4] KARITHIRI (Dark flame) The Centromere of Cosmo Universe – IJIRD, May issue, 2013
- [5] MA-AYYAN of MARS – IJIRD, June issue, 2013
- [6] MARS TRIBE – IJSER, June issue, 2013
- [7] MARS MATHEMATICS – IJERD, June issue, 2013

- [8] MARS (EZHEM) The mother of All Planets – IJSER, June issue, 2013
- [9] The Mystery of Crop Circle – IJOART, May issue, 2013
- [10] Origin of First Language – IJIRD, June issue, 2013
- [11] MARS TRISOMY HUMAN – IJOART, June issue, 2013
- [12] MARS ANGEL – IJSTR, June issue, 2013
- [13] Three principles of Akkie Management (AJIBM, August issue, 2013)
- [14] Prehistoric Triphthong Alphabet (IJIRD, July issue, 2013)
- [15] Prehistoric Akkie Music (IJST, July issue, 2013)
- [16] Barack Obama is Tamil Based Indian? (IJSER, August issue, 2013)
- [17] Philosophy of MARS Radiation (IJSER, August 2013)
- [18] Etymology of word “**J**” (IJSER, September 2013)
- [19] NOAH is Dravidian? (IJOART, August 2013)
- [20] Philosophy of Dark Cell (Soul)? (IJSER, September 2013)
- [21] Darwin Sir is Wrong?! (IJSER, October issue, 2013)
- [22] Prehistoric Pyramids are RF Antenna?!... (IJSER, October issue, 2013)
- [23] HUMAN IS A ROAM FREE CELL PHONE?!... (IJIRD, September issue, 2013)
- [24] NEUTRINOS EXIST IN EARTH ATMOSPHERE?!... (IJERD, October issue, 2013)
- [25] EARLY UNIVERSE WAS HIGHLY FROZEN?!... (IJOART, October issue, 2013)
- [26] UNIVERSE IS LIKE SPACE SHIP?!... (AJER, October issue, 2013)
- [27] ANCIENT EGYPT IS DRAVIDA NAD?!... (IJSER, November issue, 2013)
- [28] ROSETTA STONE IS PREHISTORIC “THAMEE STONE” ?!... (IJSER, November issue, 2013)
- [29] The Supernatural “CNO” HUMAN?... (IJOART, December issue, 2013)
- [30] 3G HUMAN ANCESTOR?... (AJER, December issue, 2013)
- [31] 3G Evolution?... (IJIRD, December issue, 2013)
- [32] God Created Human?... (IJERD, December issue, 2013)
- [33] Prehistoric “J” – Element?... (IJSER, January issue, 2014)
- [34] 3G Mobile phone Induces Cancer?... (IJERD, December issue, 2013)
- [35] “J” Shall Mean “JOULE”?... (IRJES, December issue, 2013)
- [36] “J”- HOUSE IS A HEAVEN?... (IJIRD, January issue, 2014)
- [37] The Supersonic JET FLIGHT-2014?... (IJSER, January issue, 2014)
- [38] “J”-RADIATION IS MOTHER OF HYDROGEN?... (AJER, January issue, 2014)
- [39] PEACE BEGINS WITH “J”?... (IJERD, January issue, 2014)
- [40] THE VIRGIN LIGHT?... (IJCRAR, January issue 2014)
- [41] THE VEILED MOTHER?... (IJERD, January issue 2014)
- [42] GOD HAS NO LUNGS?... (IJERD, February issue 2014)
- [43] Matters are made of Light or Atom?!... (IJERD, February issue 2014)

5. Hypothesis:

a) J-Particles have energy?...

It is hypothesized that the “**J-particles**” shall be considered always “**Co-exist**” and never be separated. In other words the J-particles, shall be considered as “**most fundamental particles**” and can’t be further subdivided. Further the particles shall be considered as having **electric, magnetic, optic, polarity**, property and derives constant energy from “**DARK FLAME**” of Universe.

The energy derived from the particles shall be called as “**Neutrino energy**” (or) “**FREE RADIANT ENERGY**”. This free radiant energy shall be considered as the “**Source of white energy**” utilised by 1st generation human for their **communication purpose**. The J-particles shall be called in pre-historic tamil pronounced as “**MUTHU**”. Muthu shall mean source of “**WHITE ENERGY**”. **ATOM** is smallest unit of matter?... **NO... NO... NO... MUTHU** shall be considered as the smallest unit of matter and even **HYDROGEN** shall be considered as the plasma stage atom and considered evolved from most fundamental unit **MUTHU**.



(MUTHU)

- i) Right dot – **PROTON**
- ii) Left dot – **ELECTRON**
- iii) Centre dot – **PHOTON**

b) ”J-particles” have any genetic structure?...

It is hypothesized that the “**J-particles**” shall be considered exist with well defined “**genetic structure**” and subject to sustained pendulum like oscillation. The “**pendulum like oscillation**” shall be

considered equivalent to “**Human Respiration**” which shall be called in prehistoric Tamil pronounced as “**MUCHU**”. Muchu shall mean source of “**PULSE GENERATOR**” through consistent action of **Inspiration, Expiration.**

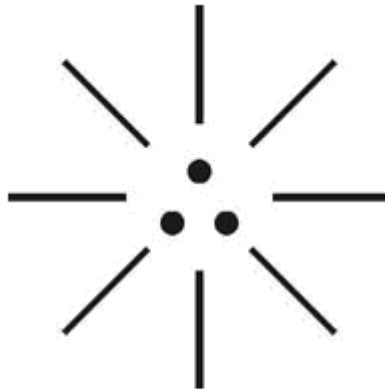

(MUCHU)

- i) Right dot – **Right nostril**
- ii) Left dot – **Left nostril**
- iii) Centre dot – **Middle point of pendulum.**

“The act of respiration shall be considered as like Pulse generator delivers consistent neutrino energy. The neutrino energy shall also be considered as HUMAN SOUL”

... Author

c) **J-Spectrum has three species?...**

In expanding universe “**Three Band**” of spectrum considered as “**evolved**” from fundamental **natural spectrum** in different Nuclear age. Each Band of spectrum shall be considered as pertain to distinguished “**family**”. The each family of spectrum shall be called in prehistoric tamil pronounced as “**MUKAM**” (band) and three-in-one existence of spectrum pronounced as “**MUKKULAM**” (family). The total **matter universe** shall be called “**MURAM**”.

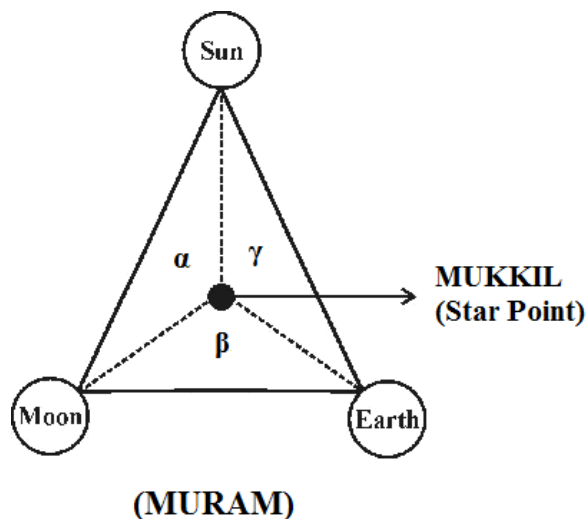

In the natural spectrum each **“Family”** shall be considered as having its own colour identity which are responsible for existence of **‘Billions of colour rays’** in material universe. The total Universal natural spectrum existence shall be considered as electromagnetic cord called in prehistoric Tamil as **MURUKKU**.

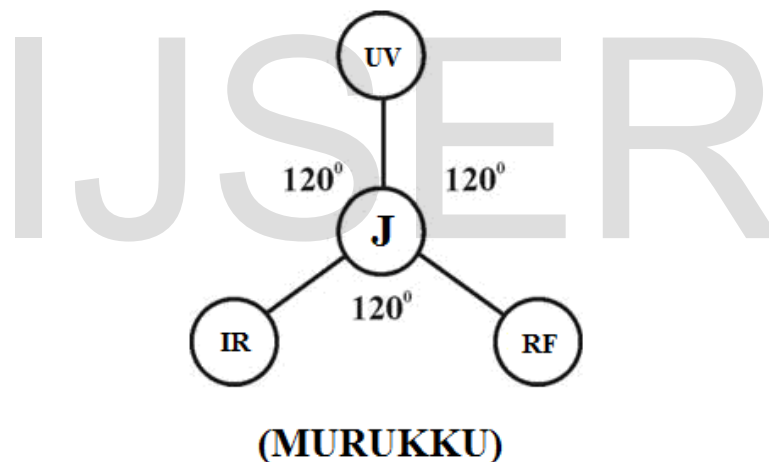

- i) UV - family **(BLUE BAND)**
- ii) RF - family **(GREEN BAND)**
- iii) IR - family **(RED BAND)**

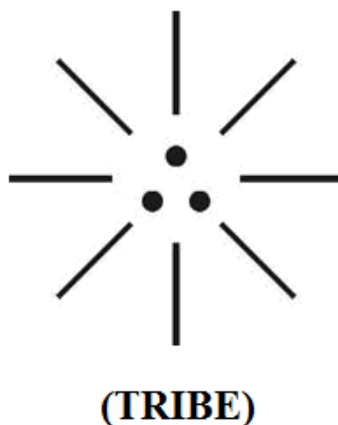

d) **Philosophy of Evolved spectrum?...**

In the matter universe “**MUKKIL**” shall be considered as naturally “**CREATED SPECTRUM**” in the early universe on Origin. During the course of “**Space**” and “**Time**” the three Band of spectrum shall be considered as evolved in the following “**sequence**” in three “**nuclear age**”.

- i) In first stage the genetically well defined “**MUKKIL**” shall be considered as become “**MUKKIL - PLASMA**” Mukilplasma shall be considered as the “**ORIGIN POINT**” of becoming genetically varied new matter. In other words every matter in the universe shall be considered as evolved from “**MUKKIL-PLASMA**” Mukkil plasma shall also be considered as “**TRANSIT STAGE**” to gain “**New genetic structure**”
- ii) Every matter in the universe shall be consistently evolved in three nuclear age and become genetically varied three main family.

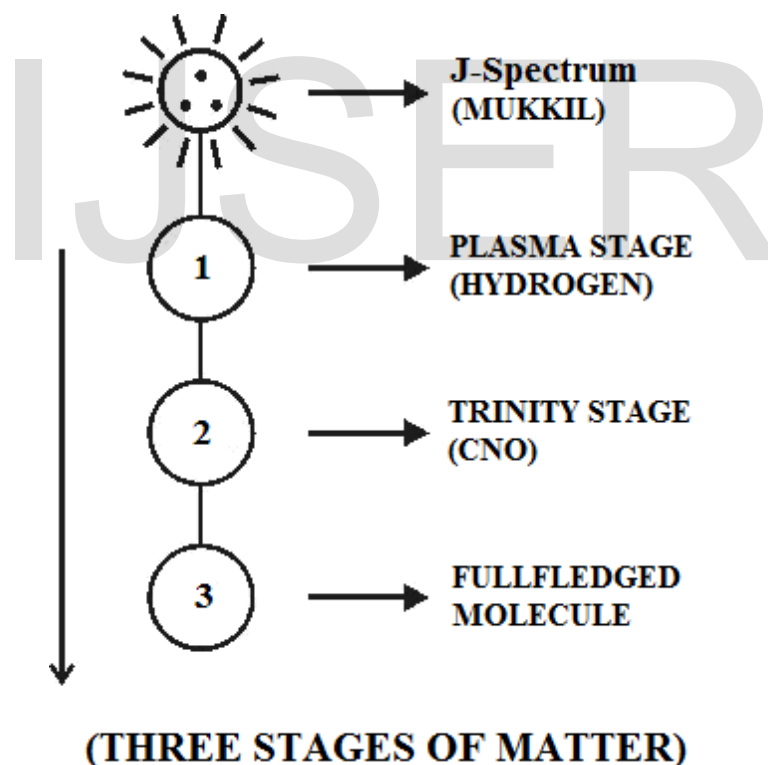

e) **Mukkil matter can fly?...**

It is hypothesized that the **1st generation** matter shall be considered having **particle behaviour** and capable of **flying**. The **2nd** and **3rd** generation matter shall be considered gained **wave property** and **non-wave property** subsequently. In the whole Cosmo universe

Mukkil, Mukkulam spectrum shall be considered existing under **Region III of universe** shown as below.

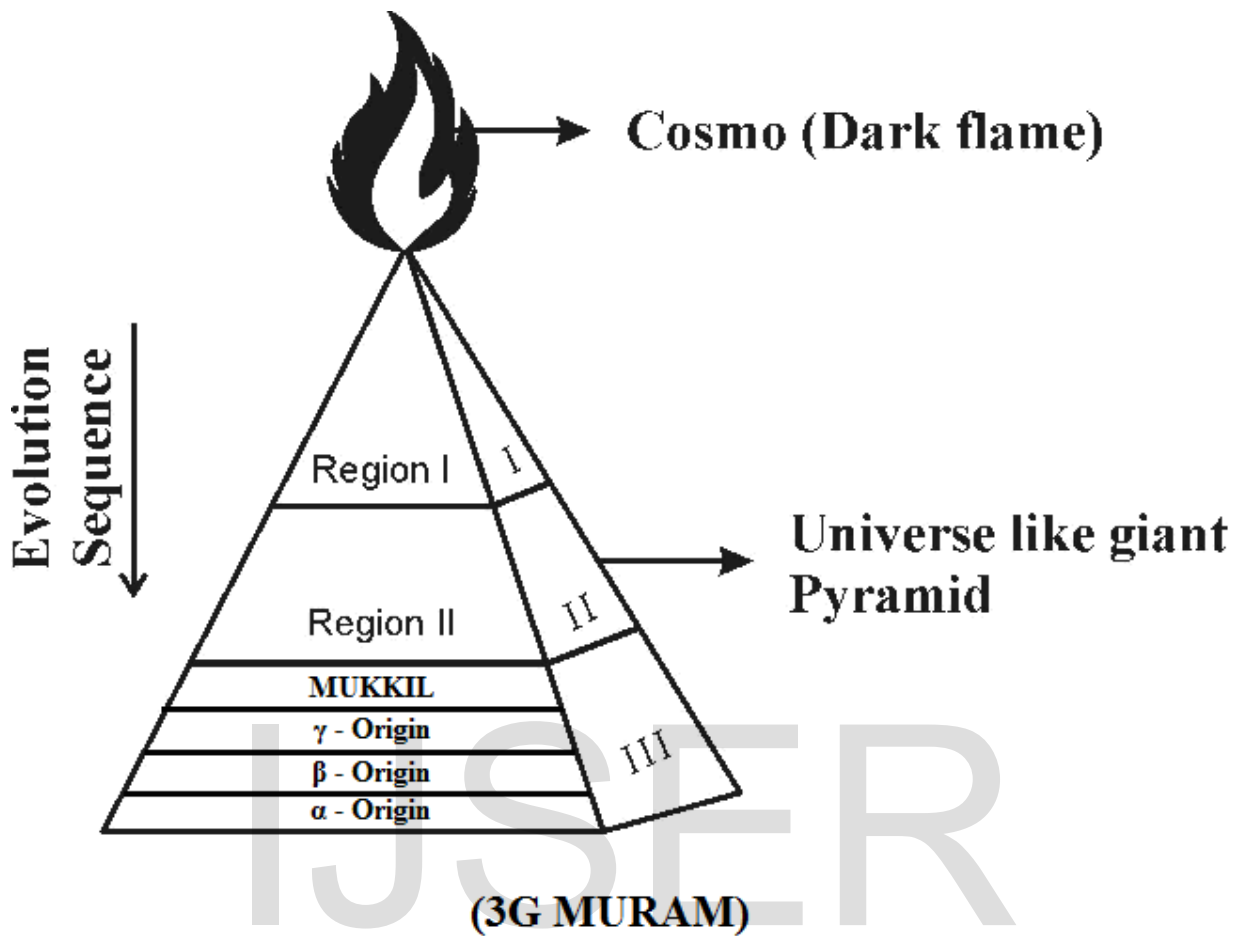

- (i) J-Radiation --- origin
- (ii) γ -Radiation --- 1st generation spectrum.
- (iii) β -Radiation --- 2nd generation spectrum.
- (iv) α -Radiation --- 3rd generation spectrum.

It is focused that the philosophy of various cosmological term shall be considered derived from the philosophy of “**Prehistoric Tamil phonetics**”

Sl. No.	Tamil origin	English origin
1	Akkilem	Cosmo universe
2	Muram	Universe
3	Mulam	Soul (J)
4	Mukkil	Mother spectrum
5	Mukkulam	Children spectrum

6	Mulai	Brain
7	Mukulam	Spectral Cord
8	Muthu	Neutrino particles
9	Mukam	Band width region
10	Mudi	Ray
11	Musiri	Radiation
12	Mulai (decay)	Plasma stage origin
13	Murukku	Spectrum
14	Muchu	Oscillation, Swing
15	Munivar	Alien (Ammuthan, Thameen)

f) The philosophy of Mukkilan?...

It is hypothesized that “**Mukkilan**” shall be considered as the created product of “**Mukkil**”. Mukkilan shall be considered as capable of “**Flying**”. Mukkilan shall also be called as “**Ammuthan**”, “**Thameen**”.

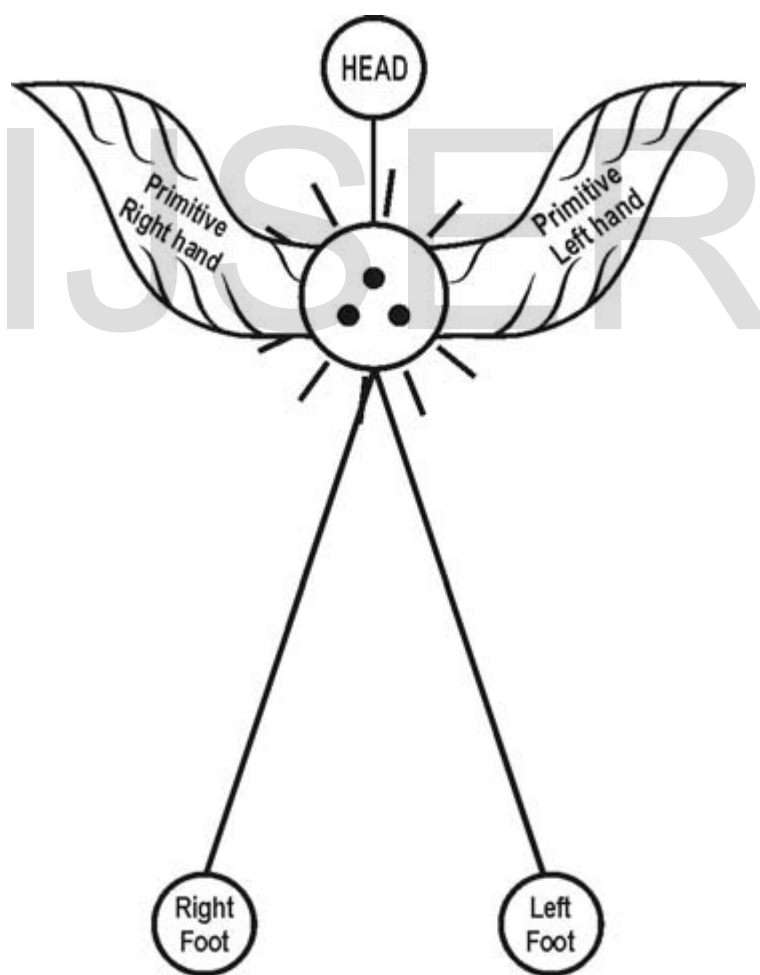

**Tamil Based Indian
 (The First Human)**

6. Hypothetical Narration

It is focused that the 1st generation human shall be considered as expert in Astrophysics, Astronomy. It is speculated that the etymological origin of cosmological term in global languages shall be considered derived from prehistoric Tamil scientific “**Akkie Code**”

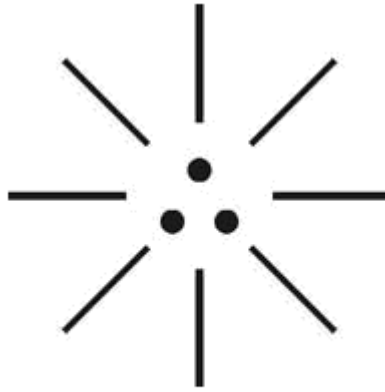

(AKKIE CODE)

a) **Philosophy of Acronym “MGR”?...**

The 1st generation human **Ammuthan, Thameen** shall also be called “**MGR**” and capable of flying. **MGR** shall mean “**MARS GEO RULER**”.

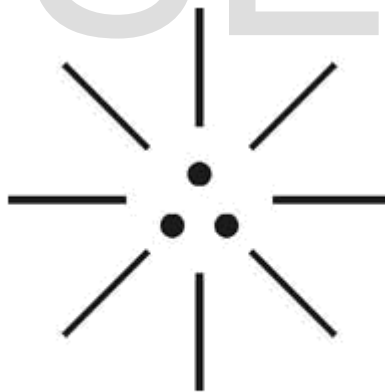

(MGR)

b) **Philosophy of crescent?...**

It is focused that the “**three stages**” of crescent shall be considered represent the relative position of “**MOON**” in three generations nuclear age.

(i)

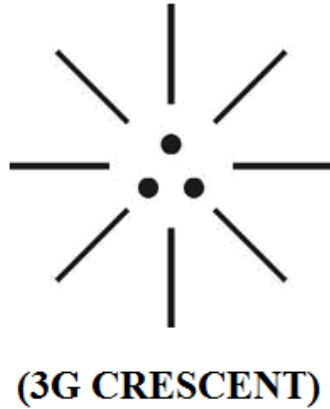

(ii)

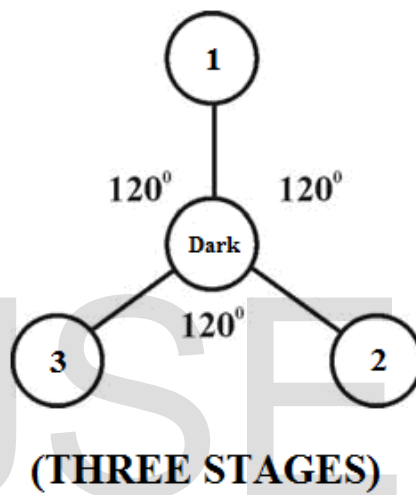

c) Philosophy of Muon?...

It quantum physics the term “**Muon**” is considered as one of the “**Neutrino particles**”. it is focused that the philosophy of Muon might be derived from the prehistoric tamil phonetics “**MUNU**”, “**MUNDRU**”. Munu, Mundru shall mean **three fundamental particles**.

(i)

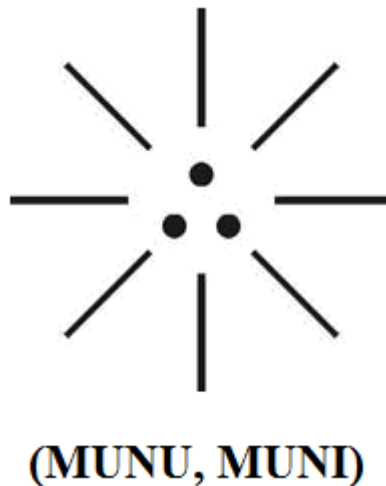

(ii)

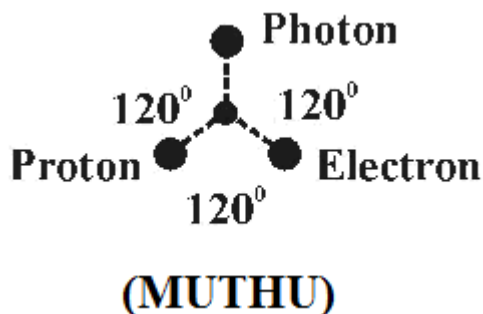

d) Philosophy of Mushroom cloud?...

Mushroom cloud refers to large cloud shaped like mushroom that forms in the air after a “**nuclear explosion**”. It is speculated that the philosophy or mushroom cloud might be derived from the philosophy of prehistoric tamil phonetics “**Mukkil**”.

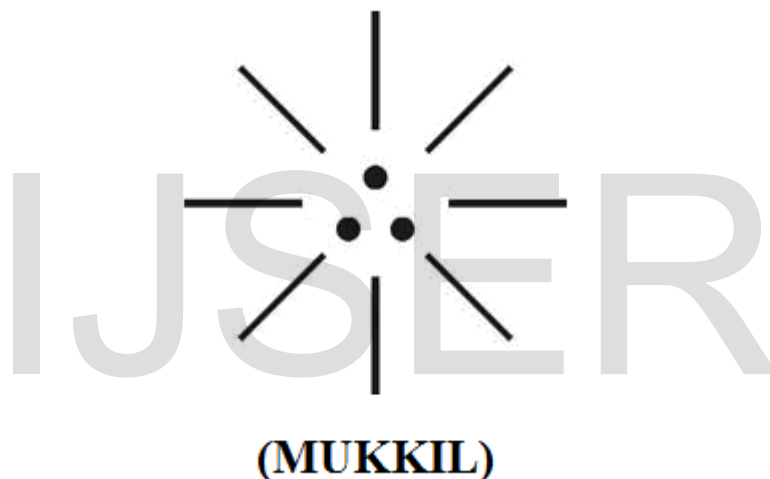

e) Philosophy of Munitions (Ammunitions)?...

It is focused that munitions, ammunitions refers to military weapons concerned with atomic explosion. It is speculated that the etymology origin of ammunition, amulet, might be derived from the philosophy of **ammu**, **ammuthan**. Ammu, Ammuthan shall mean “**Neutrino human**”.

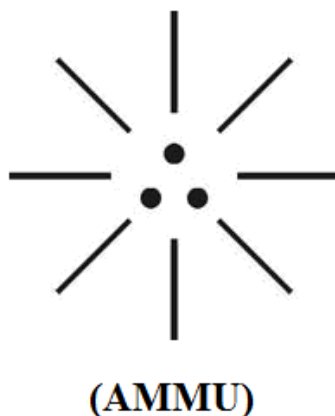

f) Philosophy of “MUKULAM and MULAI”?...

Medical Case study shows that spinal cord and brain is covered by three connective tissue envelope called “**meninges**”. It is speculated that brain shall be considered as central logic which may convey **logic pulses** in the form of PHOTON, ELECTRON, PROTON to the entire body of human system via **spinal cord**. It is focused that the Philosophy of brain, spinal cord might have been derived from the prehistoric Tamil phonetics **mulai, mukulam**.

(i)

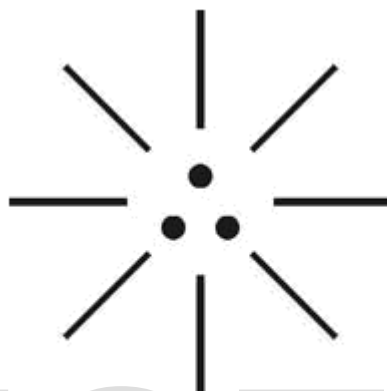

(MULAI)

(ii)

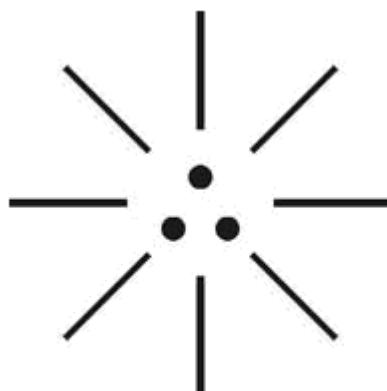

(MUKULAM)

g) Philosophy of word “KISS”?...

Case study shows that the word “Kiss” refers to sign of love and concerned with LIPS. It is focused that the 1st generation human are considered as **Godly persons** and expert in Kiss to express the real “**humanity and love**”. The philosophy of kiss might be derived from the

philosophy of prehistoric Tamil phonetics “**MbUTHAM**”. Mutham shall mean “**three-in-one**” parameter gives energy for “Life”. The Philosophy of Mutham defined within the following scope.

- (1) Motherly kiss is **Nutrine for life**
- (2) Motherly kiss is **hormone for life**
- (3) Motherly kiss is **hope for life**

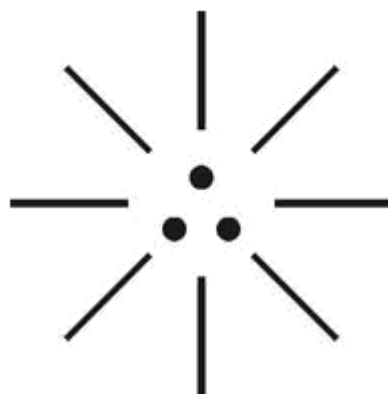

(MUTHAM)

- i) Right dot – **PROTON**
- ii) Left dot – **ELECTRON**
- iii) Centre dot – **PHOTON**

The philosophy of “**MUTHAM**” shall be considered as the integral part of “**LIPS**”, “**TONGUE**”, “**HEART**”.

- i) LIPS like **Electron**
- ii) TONGUE like **Proton**
- iii) Heart like **Photon**

h) Philosophy of Myths?...

Myth refers to a story from Ancient time especially one that was told to explain natural events (or) to describe the history of people (i.e.) Greek myths, Egyptian myths.

It is focused that the philosophy of “**J-particles**” shall be considered as God particles and considered as highly “**mystics**” and beyond normal human understanding. The philosophy of “Aether particles” focused by “**TESLA**” might be derived from the philosophy of “**MUTHU**” and still considered as myths in quantum physics. The word muthu might be pronounced dialectically as “**myths**”.

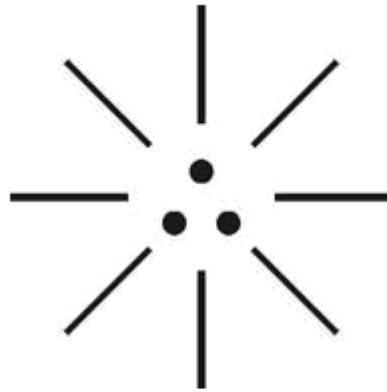

(MUTHU)

i) Philosophy of word “Mu”?...

It is speculated that the 12th letter of Greek alphabet might be derived from the philosophy of prehistoric tamil phonetics “**Munu**”. It is focused that in quantum physics the word “**JOULE**” is concerned with natural Cosmic energy. The joule is expressed as follows:

- (a) 1 Joule = 6200 Billion Electron Volts
- (b) 1 Joule per Second = 1 Watt
- (c) 1 Calorie = 4.2 Joule

It is speculated that the Philosophy of natural energy, Mu in quantum physics might have been derived from the Philosophy of three fundamental particles called in prehistoric Tamil phonetics as **MUNU**.

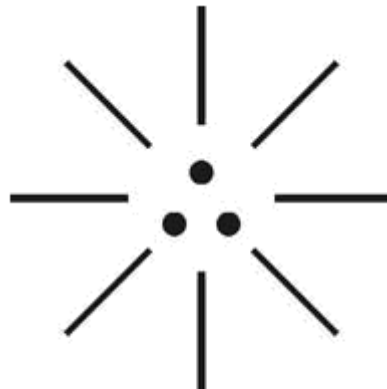

(MUNU)

j) Philosophy of word URINE?...

It is speculated that the philosophy of “**URINE**” might be derived from the philosophy of prehistoric Tamil phonetics “**MUTHIRAM**” (Nuero Fluid). Muthiram shall be considered as the natural product of fundamental “neutrino particles” **photon, electron, proton**.

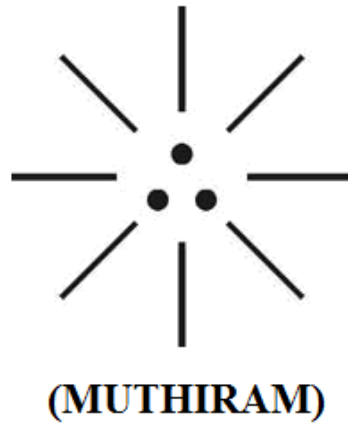

k) Philosophy of TRINITY, TRIBE?...

It is focused that the philosophy of Trinity, Tribe might be derived from the philosophy of prehistoric Tamil phonetics MUKKIL, MUKKULAM.

- i) “Trinity” shall mean “**Mukkil**”
- ii) “Tribe” shall mean “**Mukkulam**”

(i)

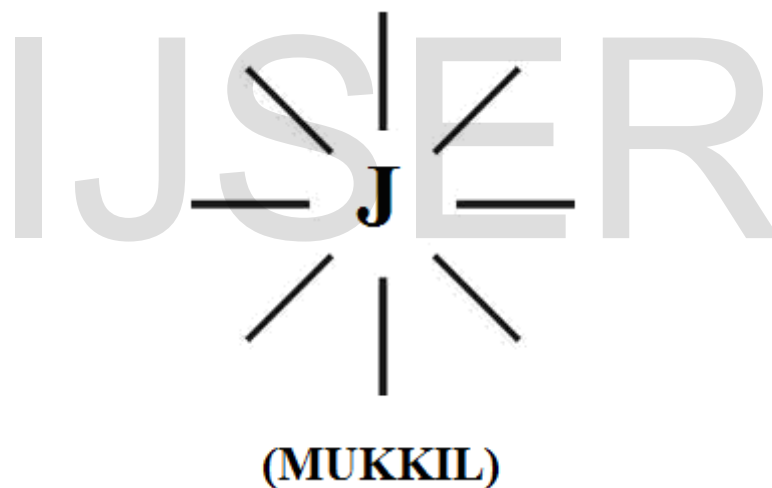

(ii)

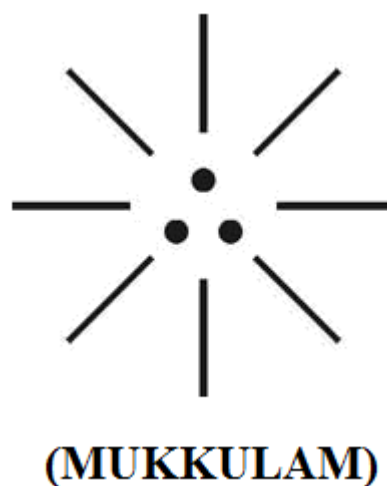

It is hypothesized that the **caste system in India** might have been derived from the Philosophy of Nuclear spectrum.

- (i) Brahman (**GOD**) – J-Family (**WHITE BAND**)
- (ii) Kshatriva (**FC**) – UV Family (**BLUE BAND**)
- (iii) Vaisya – (**BC**) – RF Family (**GREEN BAND**)
- (iv) Sudra - (**SC**) – IR Family (**RED BAND**)

1) Case study on Bible?...

It is speculated that the “**ANGEL**” shall be considered as the 1st generation human populations are “**ADAM**” shall be considered as “**Species**” to angel populations.

Further from Biblical understanding the Cosmo universe and its radiations shall be hypothetically considered as equivalent as follows:

- i) Tabernacle – Cosmo universe
- ii) BAND – UV, RF, IR
- iii) Pegs – SUN, EARTH, MOON

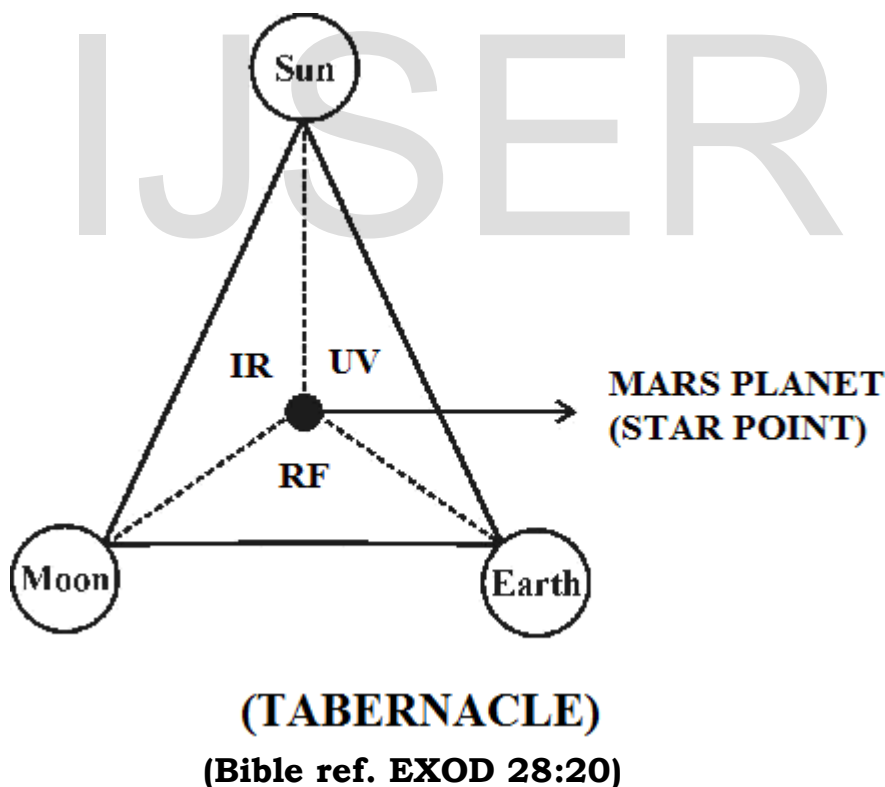

7. CONCLUSION:

In the whole cosmo universe “**GOD**” shall be considered as the Master switching centre (**MSC**) and every one shall be considered as “**3G Roam free mobile phone**” with inbuilt “**SIM**” identity. Everyone

shall be considered connected to GOD through Thin hair called **MUDI**. MUDI shall mean “**Electromagnetic rope**” composed three-in-one fundamental particles **photon, electron, proton**. It is focused that the Philosophy of “Trichology” (Scientific Hair Study) might be derived from the Philosophy of prehistoric Tamil phonetic **MUDI**.

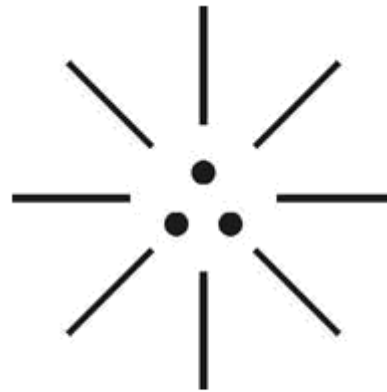

(MUDI)

8. REFERENCE

- a) Intensive Internet “e-book” study through, Google search and wikipedia
- b) M.Arulmani, “3G Akkanna Man”, Annai Publications, Cholapuram, 2011
- c) M. Arulmani; V.R. Hemalatha, “Tamil the Law of Universe”, Annai Publications, Cholapuram, 2012
- d) Harold Koontz, Heinz Weihriah, “Essentials of management”, Tata McGraw-Hill publications, 2005
- e) M. Arulmani; V.R. Hemalatha, “First Music and First Music Alphabet”, Annai Publications, Cholapuram, 2012
- f) King James Version, “Holy Bible”
- g) S.A. Perumal, “Human Evolution History”
- h) “English Dictionary”, Oxford Publications
- i) Sho. Devaneyapavanar, “Tamil first mother language”, Chennai, 2009
- j) Tamilannal, “Tholkoppiar”, Chennai, 2007
- k) “Tamil to English Dictionary”, Suravin Publication, 2009
- l) “Text Material for E5 to E6 upgradaton”, BSNL Publication, 2012
- m) A. Nakkiran, “Dravidian mother”, Chennai, 2007

- n) Dr. M. Karunanidhi, "Thirukkural Translation", 2010
- o) "Manorama Tell me why periodicals", M.M. Publication Ltd., Kottayam, 2009
- p) V.R. Hemalatha, "A Global level peace tourism to Veilankanni", Annai Publications, Cholapuram, 2007
- q) Prof. Ganapathi Pillai, "Sri Lankan Tamil History", 2004
- r) Dr. K.K. Pillai, "South Indian History", 2006
- s) M. Varadharajan, "Language History", Chennai, 2009
- t) Fr. Y.S. Yagoo, "Western Sun", 2008
- u) Gopal Chettiar, "Adi Dravidian Origin History", 2004
- v) M. Arulmani; V.R. Hemalatha, "Ezhem Nadu My Dream" - (2 Parts), Annai Publications, Cholapuram, 2010
- w) M. Arulmani; V.R. Hemalatha, "The Super Scientist of Climate Control", Annai Publications, Cholapuram, 2013, pp 1-3

IJSER